

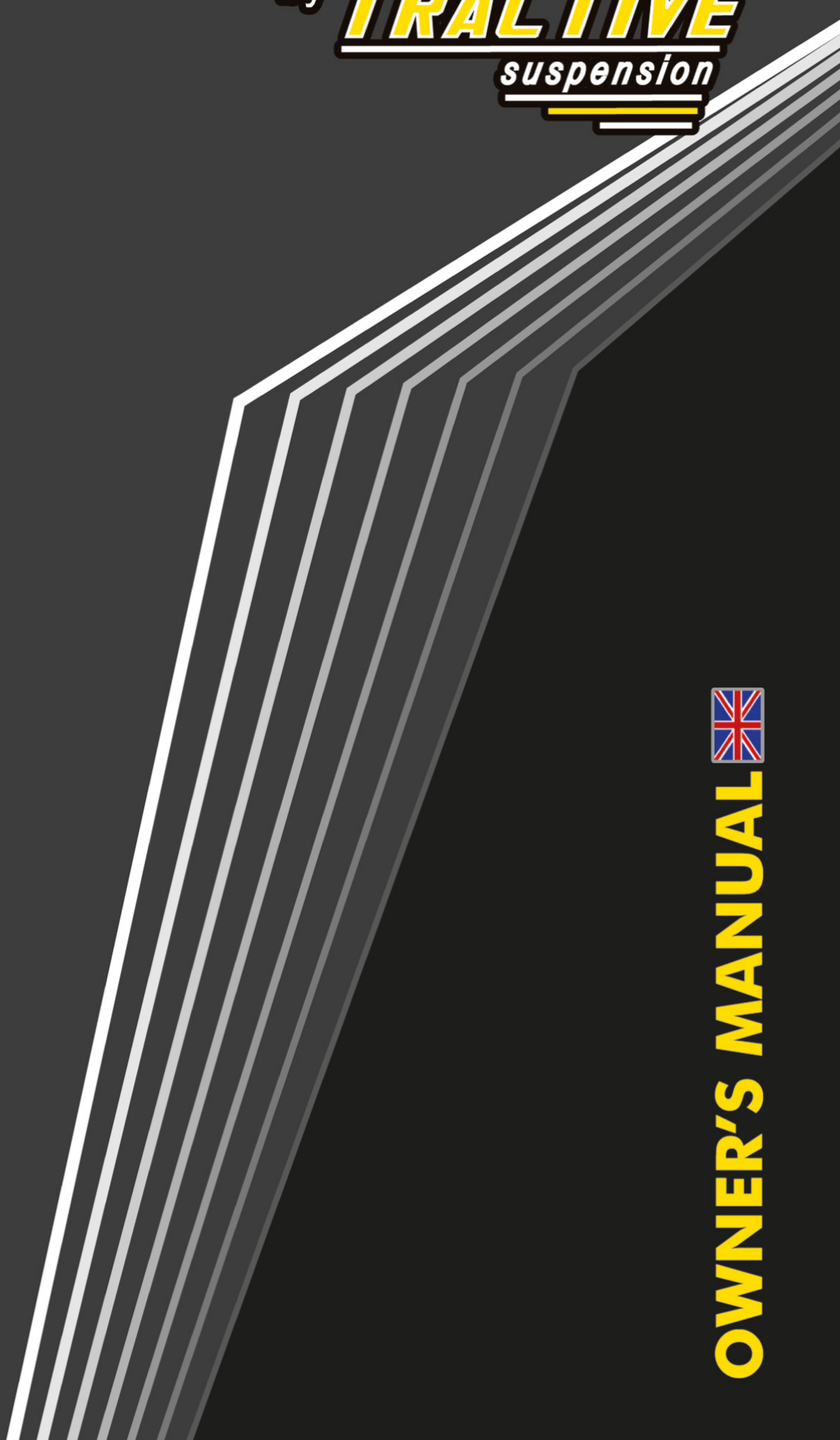

TOURATECH

by *TRACTIVE*
suspension



OWNER'S MANUAL



French
Italiano
Español

shop.touratech.com



Cartridge KIT Extreme



In this manual:

	page
1 Important Safety Symbols	4
2 Cartridge design and function	5
3 Mounting in fork	5
4 Set-up the vehicle	5
5 Adjust spring preload	6
6 How to set the preload	7
7 Removal and re-fitting spring	7
8 Rebound damping	7
9 Compression damping	8
10 Air release screw	8
11 Which adjuster to change?	8
12 Maintenance and inspection	9



1 Important Safety Symbols

In this manual, mounting instructions and other technical documents, important information concerning safety is distinguished by the following notations.



WARNING!

The warning symbol means: Failure to follow warning instructions can result in severe or fatal injury to anyone working with, inspecting or using the shock absorber, or bystanders.



ATTENTION!

The caution symbol means: special precautions must be taken to avoid damage to the shock absorber or to the electric preload adjuster.



NOTE!

The note symbol indicates information that is important regarding procedures.

Read these Safety Precautions before installing the product.



This product was developed and designed exclusively for a specified vehicle and shall only be installed on the intended vehicle in its original conditions as delivered from the vehicle manufacturer.



This product contains pressurized nitrogen gas (N₂). Do not open, service or modify this product without proper education and proper Tractive tools.



After installing this product take a test ride at low speed to make sure that your vehicle has maintained its stability.



If the function of the shock is irregular or if it makes an abnormal noise or if you notice any leakage from the product, stop the vehicle immediately and return the product to a Tractive Suspension retailer.



Read and make sure that you understand the information in this manual and the mounting instructions before you use this product.



Tractive Suspension B.V. cannot be held responsible for any damage to the shock absorber, vehicle, other property or injury to persons, if the instructions for installing and maintenance are not followed exactly.



When working on this product, always read the Vehicle Service Manual.

2 Cartridge design and function

The Cartridge in this manual is a closed cartridge type. This means that the cartridge is already filled with oil when you open the package. Remember that the oil inside is shockabsorber oil. The oil inside the package is the required frontfork oil for lubricating the bearings etc. (outside the cartridge) This closed cartridge has a bladder inside which separates the oil from the gas. Pressurization of the fluid is made with nitrogen. Closed cartridge models biggest advantage is that they create immediate damping when moving.

The cartridge can be adjusted from the top. One side rebound and the other side compression.



We recommend to install the rebound leg on the right side. (Easier to remember.

Rebound – Right)

Also the preload of the springs of both legs can be adjusted. (See chapter 6)

How does this cartridge work?

The cartridge in this manual works the same way as a shockabsorber. Oil is forced through needle valves at a low rate of flow and through a number of orifices in the piston at a high rate of flow. The flow through these orifices is regulated by shims (thin steel washers) that at high pressure are deflected to open for the oil to pass. The needle valve can be adjusted from the outside. By altering the size of the shim-stack the characteristics of the damping action can be changed.



Damping action altering can only be done by an authorized *Tractive* Suspension retailer.

3 Mounting in fork

For removal and re-fitting read the mounting instruction. Tool 90100068S must be used to mount the cartridge in the original outerfork tube. See picture.



4 Set-up the vehicle



Before riding, always ensure that the basic settings made by *Tractive* are intact. Adjust in small steps and make only one adjustment at a time.

Spring preload: spring preload is a crucial part of setting your vehicle since it affects the height of the vehicle and the fork angle.

Follow this procedure to set-up the spring preload.

- Lift up the front to a fully extended position. (when the front wheel can rotate)
- Measure the distance of the chrome tube. (b)
- Put the vehicle back on the wheels. (without rider) and repeat the measuring procedure. (c)
- Then take the same measurements with the rider and equipment on the motorcycle. (d) It 's important that the rider is balancing on the correct riding posture and repeat the measuring procedure one more time.



Recommended measurements

If no other recommendation are given in the Mounting Instructions follow the measures below:

Free sag:

Distance (b) minus distance (c) = called the free sag.

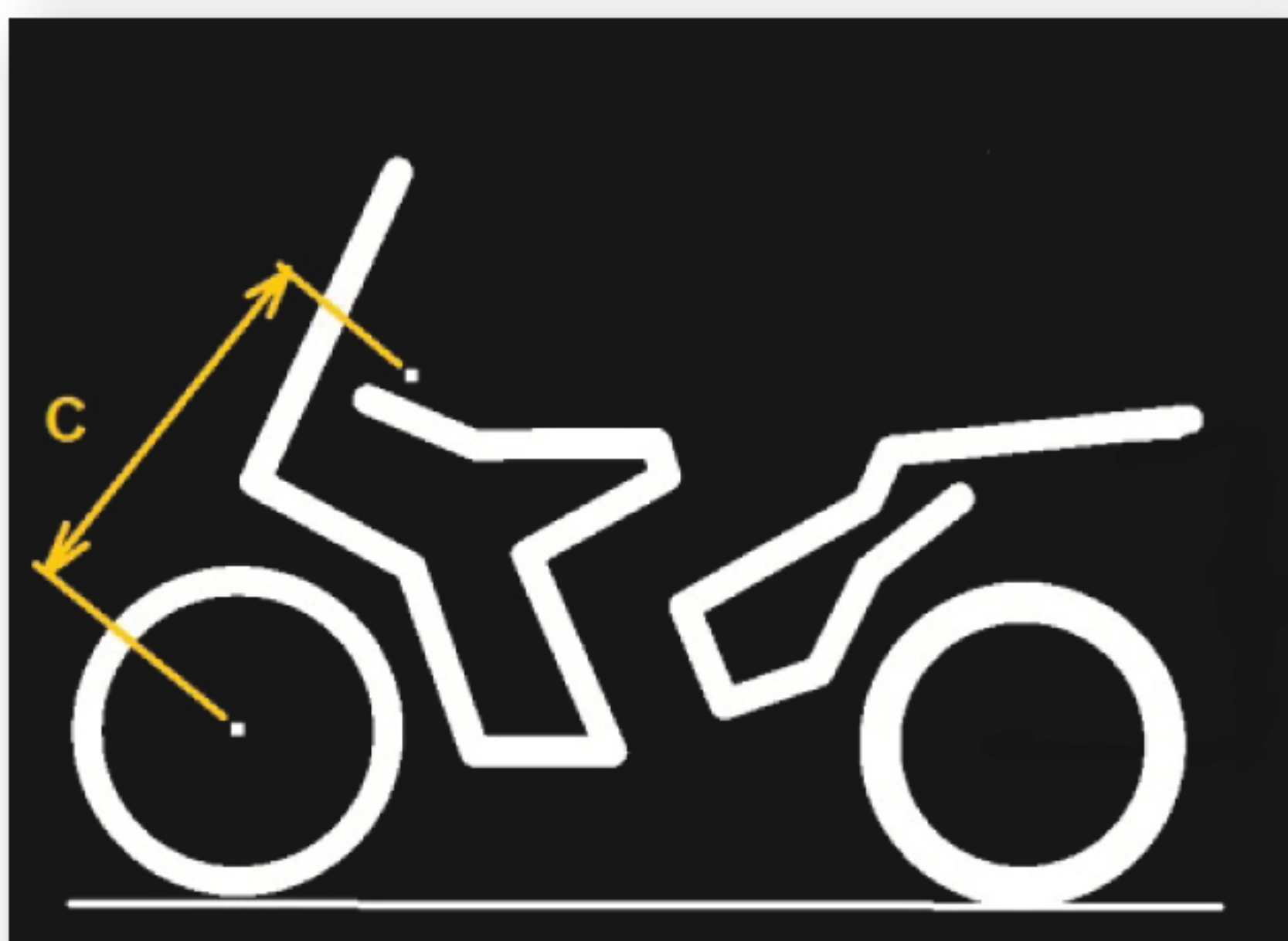
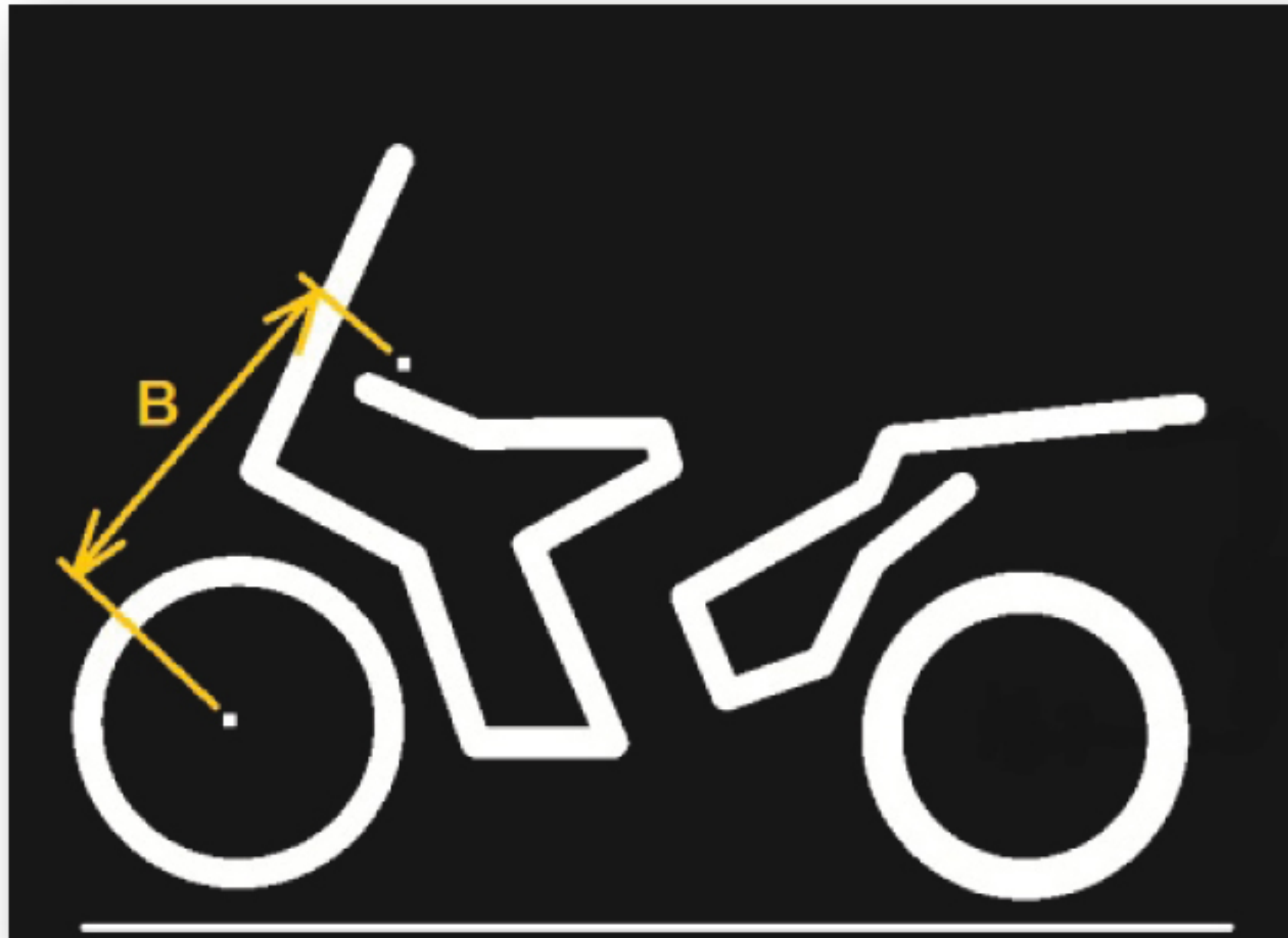

Free sag: Is approx. 10% of the wheel travel.

Ride height:

Distance (b) minus distance (d) = called the ride height.



5 Adjust spring preload

If your free sag measurements differ significantly from the recommendations then you must adjust the hexagon on top of one or both forks. (See chapter-5 How to set the preload).

If after this adjustment your ride height is still not between the recommendations, you may need to change to a softer spring when the ride height is less than 20%. Or to a harder spring when the free sag is more than 40%. (See chapter 6- Removal and re-fitting another spring)



Incorrect spring rate may result in a geometry that is either too steep or too flat.

This can result in a tendency of under or over steering, that could seriously affect the handling characteristics of the vehicle.

6 How to set the preload

It's easy to set the preload of the cartridge. Simply screw the hexagon on top of both legs. Clockwise is more preload and anti clockwise is less preload. One complete turn is 1mm extra preload.



 The spring preload is fundamental for the function of the suspension. If the preload is incorrectly set, any other adjustments will not help to get the intended performance from the suspension.

7 Removal and re-fitting springs

Lift the bike at the front and remove the forklegs. Open the screwcap and press the outertube down. Push the spring so far down that you can put a wrench 15mm between the spring and the screwcap. Now you can remove the screwcap using a wrench 22mm. See picture.

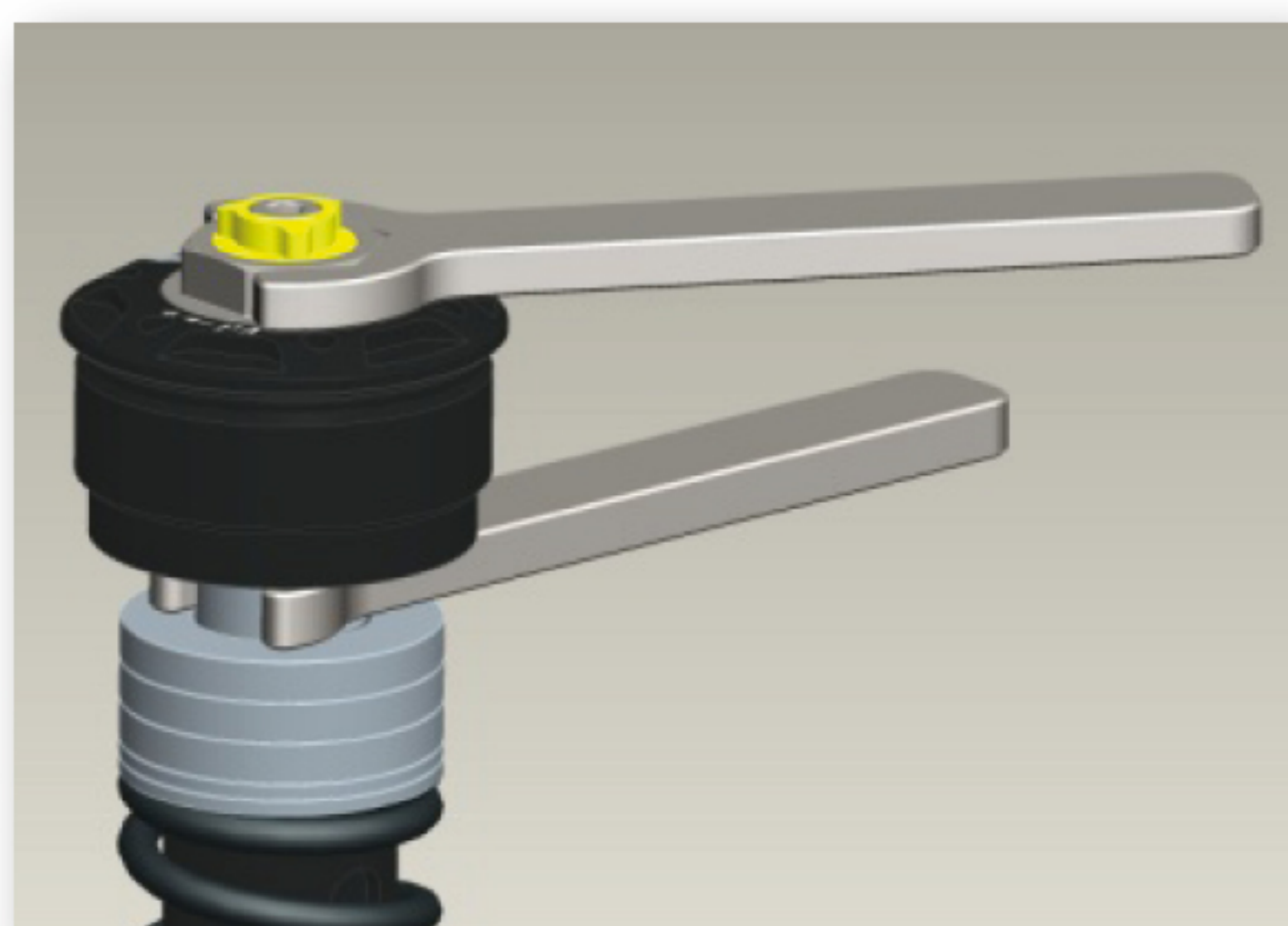

Remove the wrench 15mm by pushing the spring down again. The spring

can be removed. Re-fitting is the same procedure.



Make sure the the parts a tightened with more then 30Nm torque.

8 Rebound damping

Rebound damping controls the energy absorption when the fork is being extended and controls how fast the fork returns to its normal position after being compressed.

Rebound Damping Adjuster

Turn the hexagon screw on top of the right fork cap.(See picture) with the *Tractive* tool delivered with the shock. Turn clockwise to increase damping and turn counter clockwise to decrease it.



Reset the adjuster

Turn the adjuster clockwise to fully closed position. The first click you feel is position zero (0). Then, turn counter clockwise to open it. Count the clicks until you reach the recommended number of clicks. See recommended set-up data in the mounting instructions for the shock absorber.



The recommended number of clicks is mostly somewhere close to click 10. Set the rebound no more than ± 6 clicks from the original (basic) setting.



Do not use force, when you reach the zero click position to try to reach another click. Delicate parts can be damaged. And also do not use a lot of force at the end position of the clicker.

9 Compression damping

Compression damping controls the energy absorption when the cartridge is being compressed. The compression adjuster knob is located at the top of the screwcap on the left frontfork.

Compression damping adjuster

Turn the hexagon adjuster on top of the screwcap (See picture) with the *Tractive* tool with bit 4 mm delivered with the shock.



Turn clockwise to increase damping and turn counter clockwise to decrease it.

Reset the adjuster

Turn the adjuster clockwise to fully closed position. This is position zero (0). Then, turn counter clockwise to open it. Count the clicks until you reach the recommended number of clicks. See recommended set-up data in the mounting instruction.



The recommended number of clicks is mostly somewhere close to click 10. Set the compression no more than ± 5 clicks from the original (basic) setting.



Do not use force, when you reach the zero click position to try to reach another click. Delicate parts can be damaged. And also do not use a lot of force at the end position of the clicker.

10 Air release screw

Sometimes frontforks are sucking in air through the seals at the bottom of the outerleg. If this is happening the fork will become harder and harder while riding. On top of the screwcap we put an air release screw to solve the problem. Lift the front wheel of the ground and open the screw. The pressure inside the fork can now reduce to 0 bar again. After 1 or 2 seconds you can close the screw again.

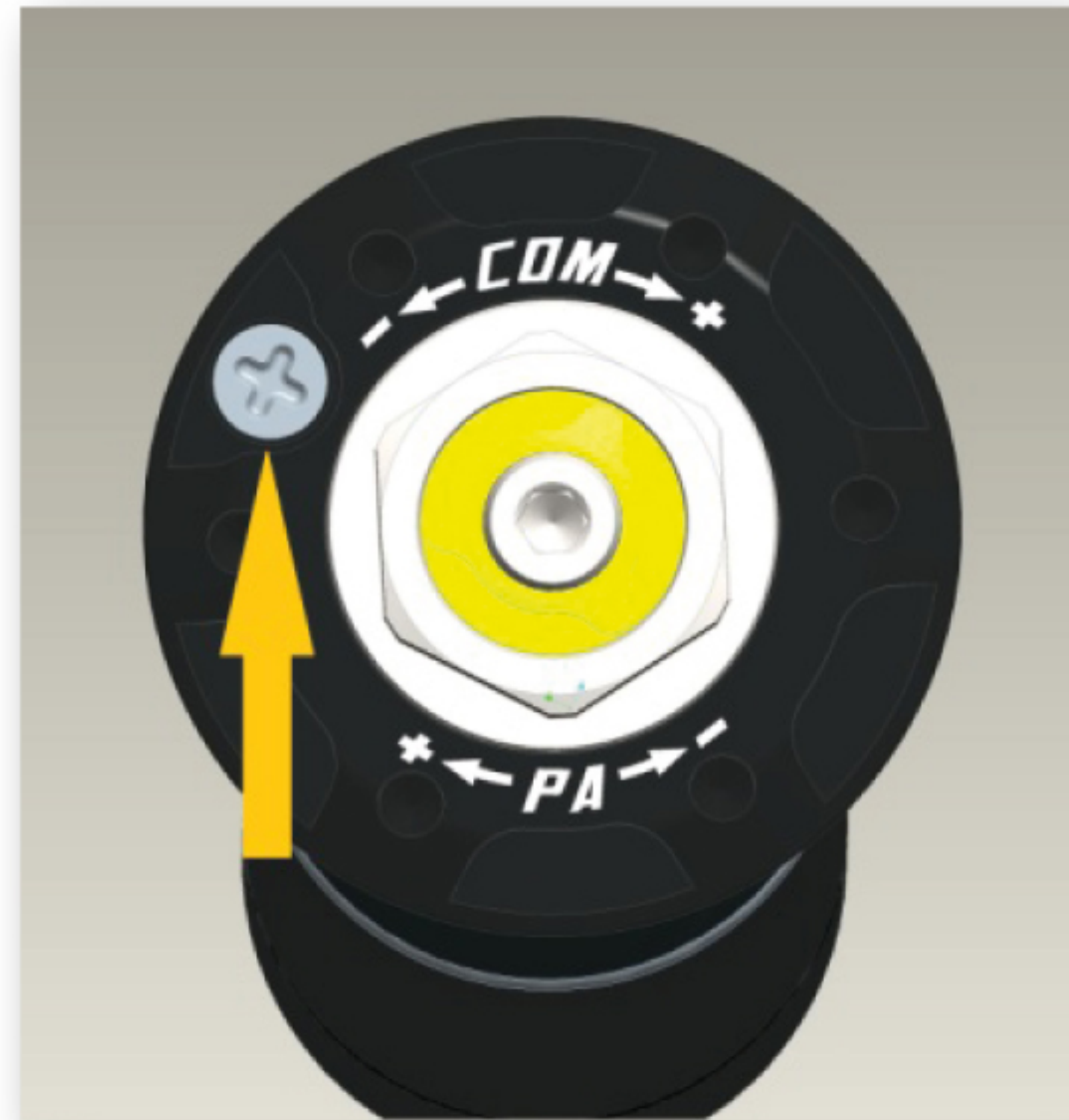

11 Which adjuster to change?

Rebound damping

If the spring, preload and ride height is correct, but the vehicle still encounters some problems on rebound please check the following options.

Increase rebound when the bike feels:

- Nervous in corners
- Moving in corners
- High feeling entering corners
- Unstable
- Loose
- Bouncy

Decrease rebound when the bike feels:

- Bike runs low
- Packs down under acceleration bumps
- Lost line
- Lost comfort
- Lost traction
- Hard
- Bumpy

Compression damping

If the spring, preload and ride height is correct, but the vehicle still encounters some problems on compression please check the following options.

Increase compression when the bike feels:

- Feels soft
- Feels unstable under acceleration
- Feels low under acceleration
- Is bottoming

Decrease compression when the bike feels:

- Harsh
- Hard
- Has bad grip
- Feels unsmooth
- Feels high



When you have sufficient feel of the vehicle you can make further fine adjustments.

Go back where you started to check if the adjustments are really an improvement.



Note that tires and temperature and other relevant factors are also influencing the performance of the suspension.

12 Maintenance and inspection

Preventive maintenance and regular inspection reduce the risk of functional disturbance. If there is any need for additional service, please contact an authorized *Tractive* Suspension Centre.

Inspection points

- 1) Check the air release screw on top of the screwcaps every half year.
- 2) Check the innertube for external damage and leakage.

Recommended Service Interval

Regular on road use: Every 30.000 km

Disposal

Discarded *Tractive* product should be handed over to an authorized *Tractive* retailer or distributor for proper disposal.



Do not open the nitrogen filling plug. Special charging tools and access to nitrogen is required to fill the cartridge with pressure again.





TOURATECH

by **TRACTIVE**
suspension

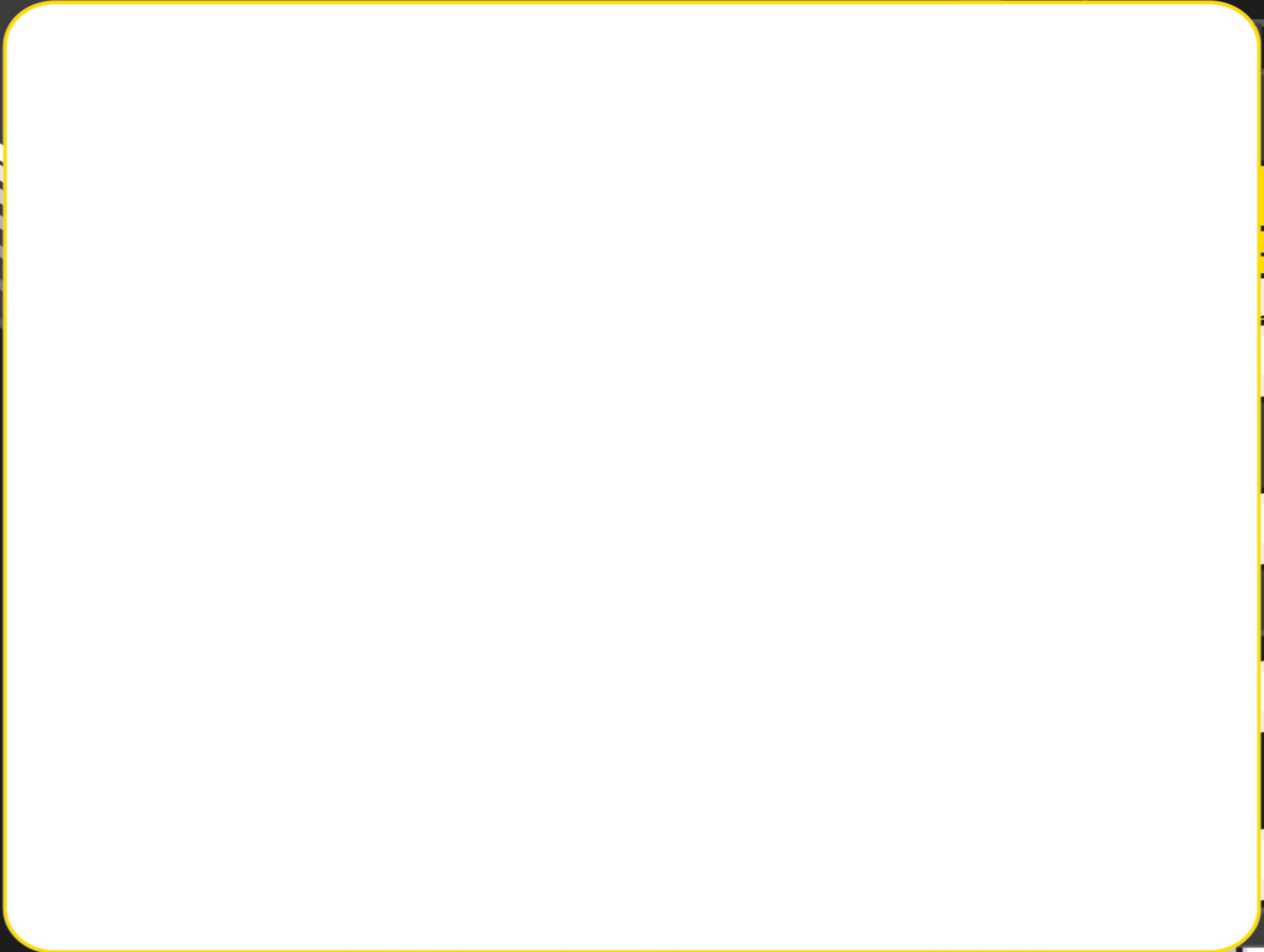

TOURATECH AG

Auf dem Zimmermann 7-9, 78078 Niedereschach, Deutschland

T+49 (0)7728-92 79-0

