



STAY IN TOUCH



cardosystems.com



cardosystems.com/support



youtube.com/CardoSystemsGlobal/



Cardo Connect App



MAN00578 MAN INSTALLATION GUIDE FOR FREECOM X_A02

Option 1

Installation on narrow rim helmet
Montage an schmalem Helm
Installation sur casque à bord étroit
Installazione su casco con bordo stretto
Instalación en el casco de borde estrecho
縁が狭いヘルメットへの取り付け
安装于窄边头盔上

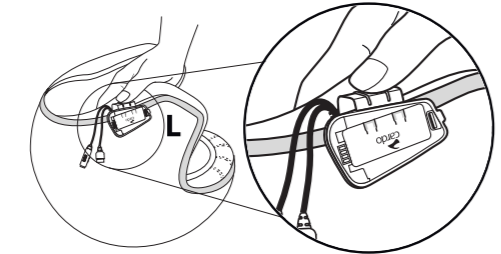
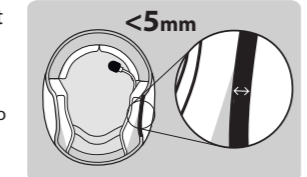

Push clamp into place
Klemme einschieben
Mettez l'attache en place
Spingi l'aletta nella posizione corretta
Empuja la abrazadera hasta que calce
クランプを所定の位置に押し込む
将夹钳推入就位

Option 2

Installation on wide rim helmet
Montage an breitem Helm
Installation sur casque à bord large
Installazione su casco con bordo largo
Instalación en el casco de borde ancho
縁が広いヘルメットへの取り付け
安装于宽边头盔上

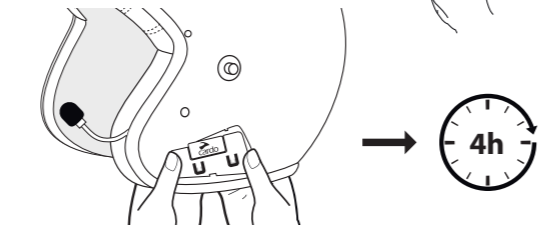
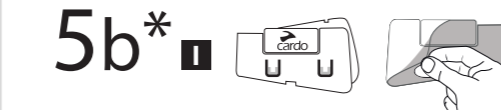
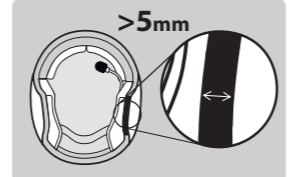

5c*

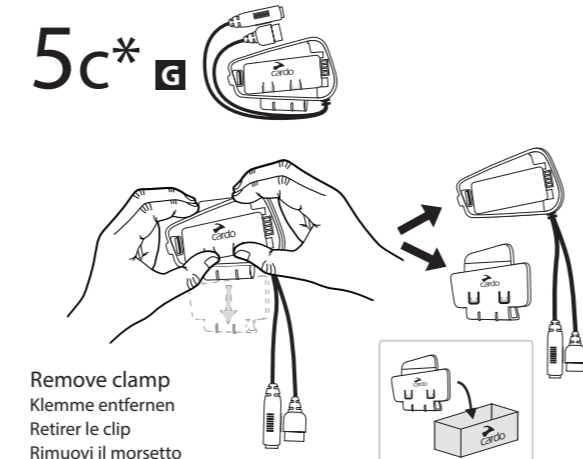

Remove clamp
Klemme entfernen
Retirer le clip
Rimuovi il morsetto
Quitar la abrazadera
クランプを取り外す
取下夹子

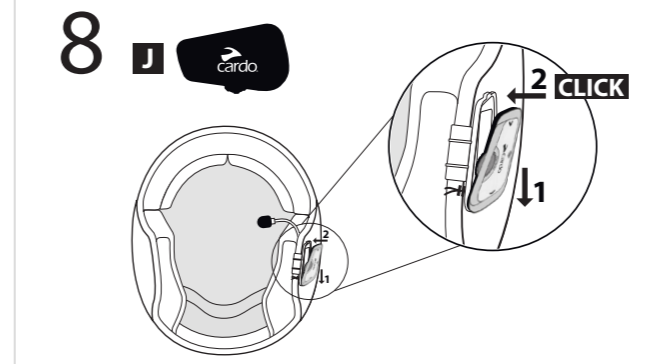
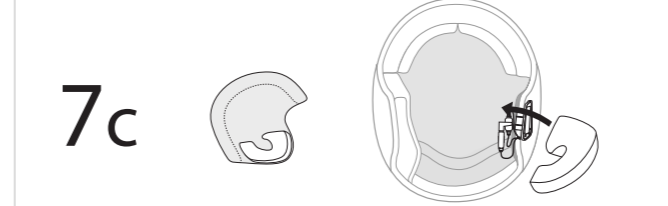
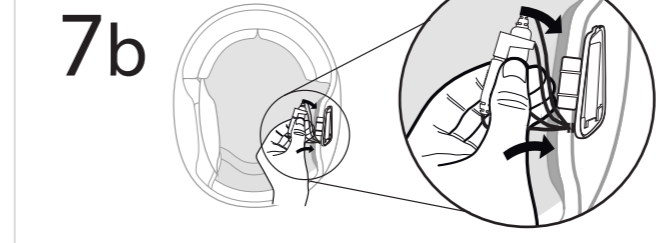
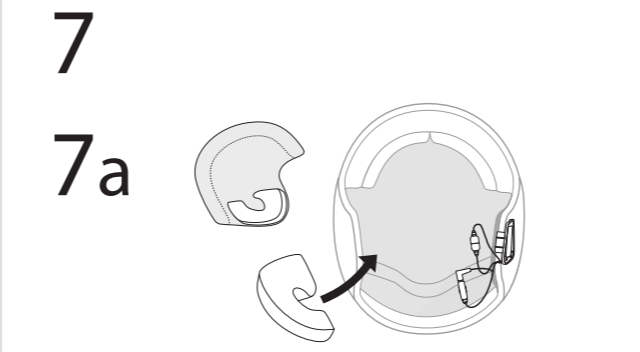
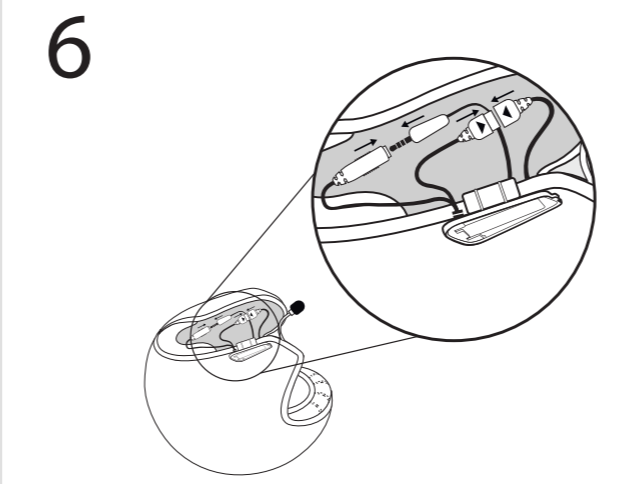
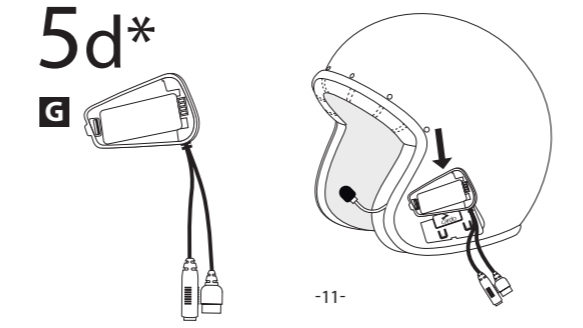

9 Optional x2
If needed, use booster pads to place speakers closer to ear
Bei Bedarf Booster-Pads verwenden, um die Lautsprecher näher am Ohr zu platzieren
Si nécessaire, utilisez des coussinets de rattrapage pour rapprocher les haut-parleurs de l'oreille
Se necessario, utilizzare i cuscinetti per posizionare gli altoparlanti più vicino all'orecchio
Si es necesario, use almohadillas de amplificadores para poner los altavoces cerca de la oreja
必要に応じて、ブースターパッドを使ってスピーカーを耳に近づけます
如果需要，请使用增强垫将耳机放置在更靠近耳朵的地方

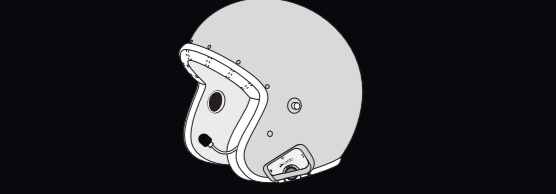
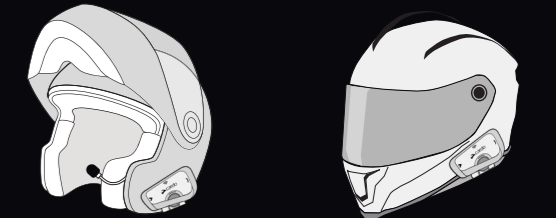
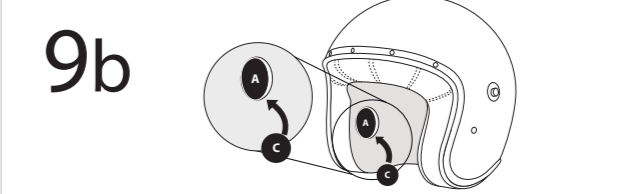
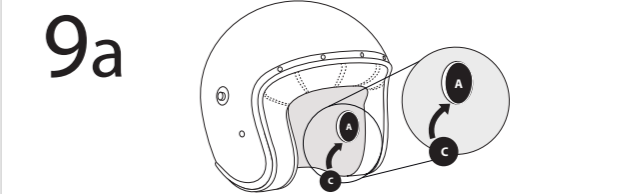

FREECOM X
Installation Guide

INSTALLATION VIDEO



Installationsvideo
Vidéo d'installation
Video d'installazione

Video de instalación
インストール動画
安装视频

CONTENTS

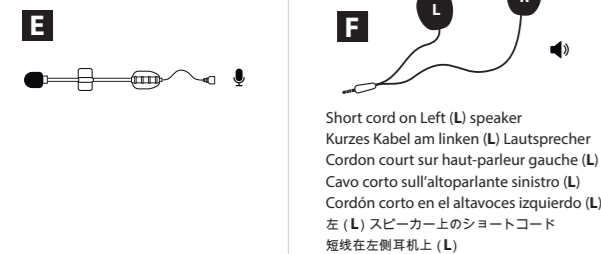
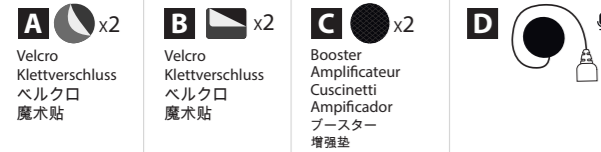

-1-

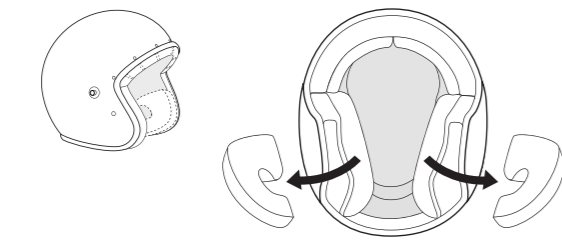
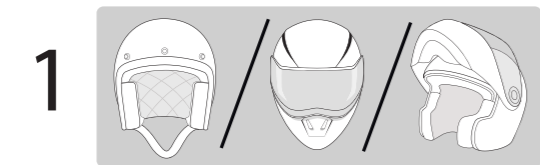

-2-

2 **A** x2

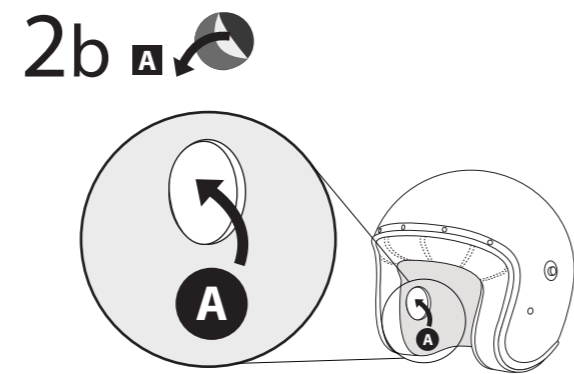
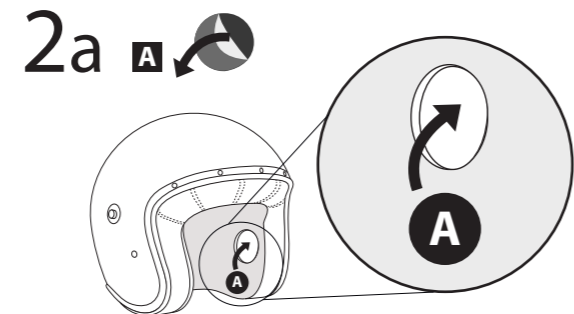

-3-

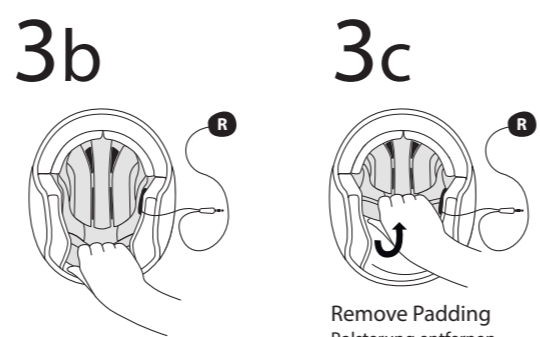
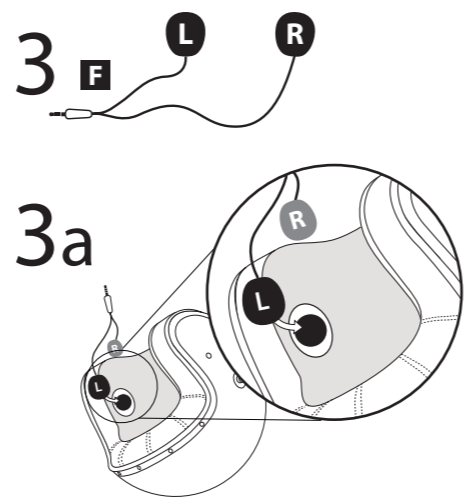

Remove Padding
Polsterung entfernen
Enlever le rembourrage
Quitar el relleno acolchado
Rimuovere l'imbottitura
パディングを取り除く
移除填充物

-4-

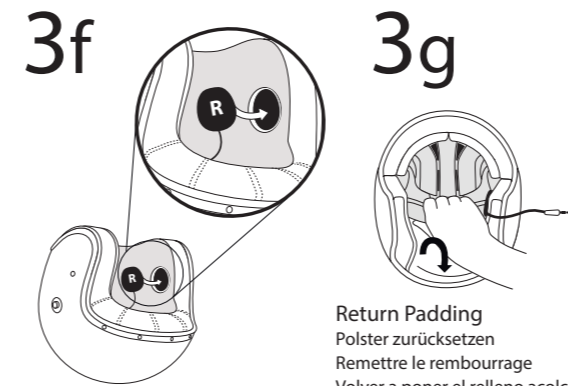
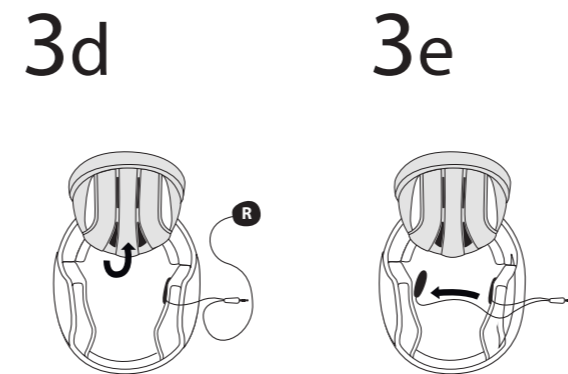

Return Padding
Polster zurücksetzen
Remettre le rembourrage
Volver a poner el relleno acolchado
Reinserire l'imbottitura
パディングを付けないおす
放回填充物

-5-

Option 1

Open face helmet installation
Installation an offenem Helm
Installation sur casque jet (open face)
Installazione su casco aperto
Instalación del casco abierto
オープンフェイスヘルメットへの取り付け
敞开式头盔安装

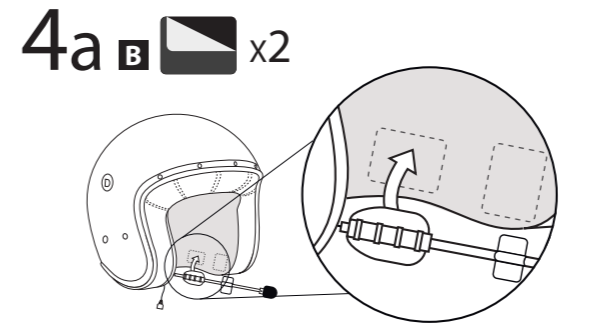
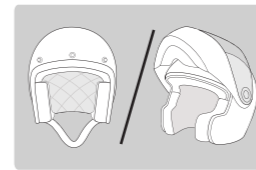

Place the mic to position the velcros
Platzieren Sie das Mikrofon, um die Klettverschlüsse zu positionieren
Placez le micro pour positionner les velcros
Posizionare il microfono per collocare i velcro
Colocar el micrófono para poner los velcros
マジックテープを位置づける為にマイクを付ける
放置麦克风以固定魔术贴

-6-

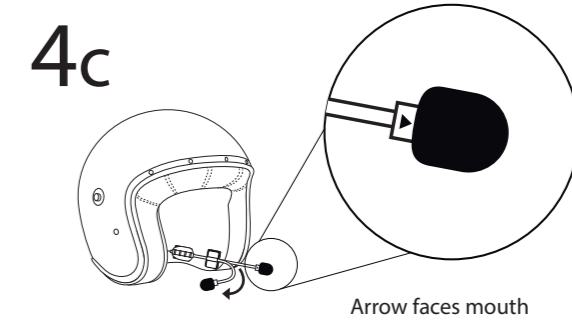
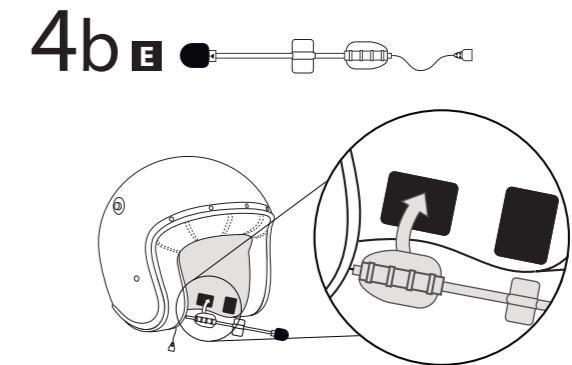

Arrow faces mouth
Pfeil zeigt zum Mund
La flèche doit faire face à la bouche
La freccia è rivolta verso la bocca
La flecha va a la boca
矢印が口に向かうように
箭头面向嘴部

-7-

Option 2

Full face helmet installation
Installation an Integralhelm
Installation sur casque intégral
Installazione su casco integrale
Instalación en el casco de cara completa
フルフェイスヘルメットへの取り付け
全面罩式头盔安装

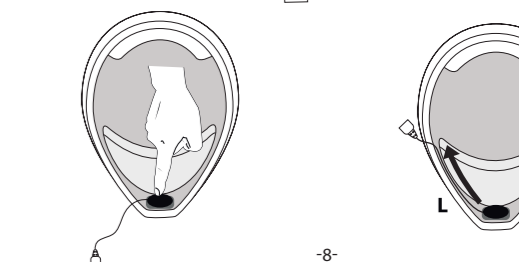
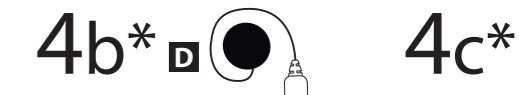
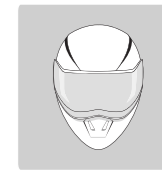

-8-

Measurements

front
90 mm

145 mm

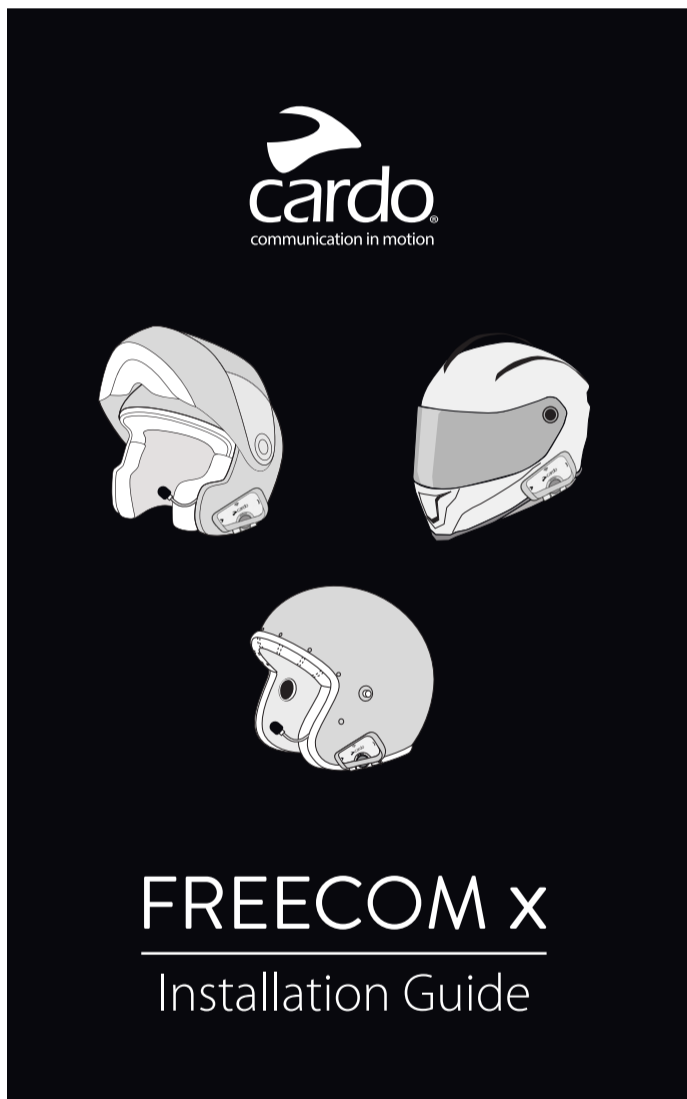

back
90 mm

145 mm

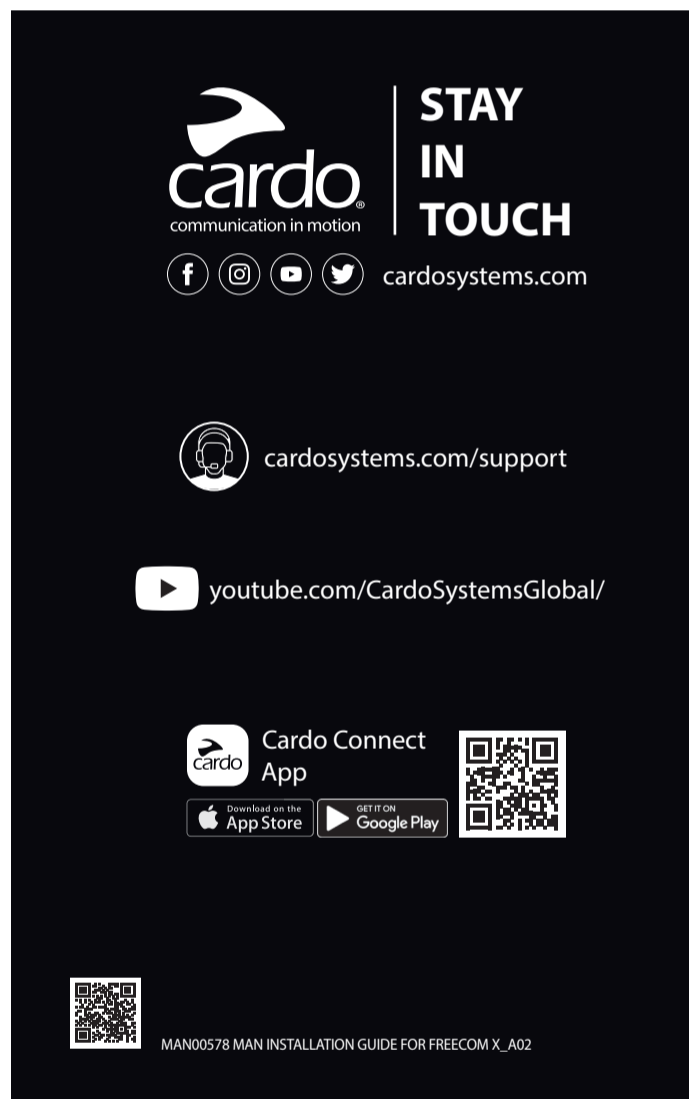

TYPE APPROVAL

P/N	MAN00578		
DESCRIPTION	INSTALLATION GUIDE		
FILE NAME	MAN00578 MAN INSTALLATION GUIDE FOR FREECOM X_A02		
LANGUAGE	illustration		
PRODUCT TYPE	MANUAL		
MATERIAL	P2 C1+1 80 gr offset folded		
PRINTING PROCESS	COLOR: BLACK / GRAY SCALE		
SECONDARY PROCESS	 		
ATTACHED FILES	1. GRAPHIC FILE - PDF 2. FOLLING INSTACTION VIDEO		
MEASUREMENT	SPREAD: 145MM-720MM , FOLDED: 145MM-90MM		
CLIENTS/ DISTRIBUTOR	 		
SPECIAL REQUIREMENT	 		
REVISION	DESCRIPTION	DATE	NAME
A02	FINAL	02.06.2021	Almog

Rev	Change Description	Date	Approved by
A01	first version	09.03.2021	Almog
A02	change the contant	02.06.2021	Almog